

**M-804**

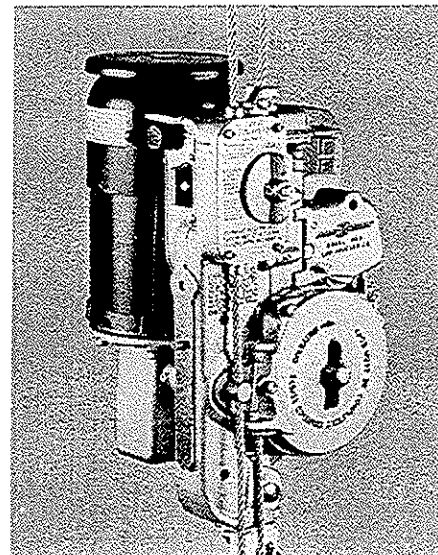

***Pocket Climber  
Operating Instructions***

***PC1 Series***

***October 1995***

*Keep this manual with the hoist at all times*

*M-804*

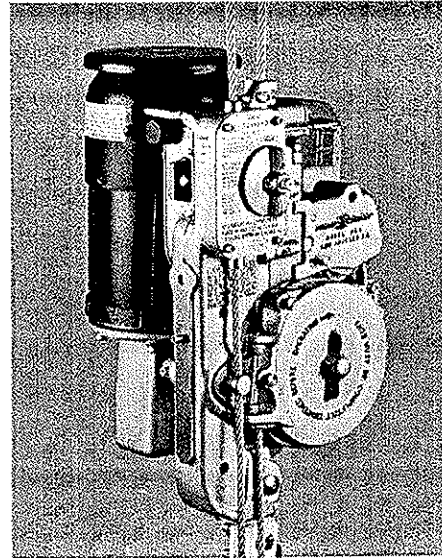

*Pocket Climber  
Operating Instructions*

*PC1 Series*

*October 1995*

*Keep this manual with the hoist at all times*

## Table of Contents

Introduction.....	3
Safety Summary.....	3
Hazard Summary.....	5
Mechanical Hazards.....	5
Electrical Hazards.....	6
Rigging Essentials.....	6
Cornice Hooks.....	7
Outrigger Beam Distance-to-Weight Ratio.....	7
Wire Rope.....	7
Hoist Description.....	9
General Specifications.....	10
Component Parts.....	10
Installing to a Platform.....	13
Reeving the Wire Rope.....	13
Installing the Main Suspension Wire Rope.....	13
Installing the Second Wire Rope.....	18
Daily Test Requirements.....	18
Testing the Secondary Overspeed Brake.....	19
Testing the Manual Emergency Down Brake.....	19
Testing the Emergency Power Cut-off Button.....	21
Testing the Second Wire Rope Brake.....	21
Testing the No-Power Emergency Descent.....	21
Daily Inspection.....	22
Operating the Hoist.....	22
Normal Operation.....	22
Cold Weather Operation.....	23
Dereeving.....	23
Removing the Second Wire Rope.....	23
Removing the Main Suspension Wire Rope.....	23
Periodic Maintenance.....	24
Troubleshooting at the Job Site.....	24

## Introduction

The Pocket Climber is used to raise and lower stages, work cages and bosun's chairs along the sides of buildings and structures. If used for any other purpose, you must take all necessary precautions to be sure that both design and operation are hazard free.

Before using the Pocket Climber, become familiar with the procedures described in this manual. This manual is included with each Pocket Climber. Additional copies are available from your Dealer. Any operation in violation of these instructions may result in bodily injury or death. The Pocket Climber is regulated by OSHA Safety Standard 1910.28 entitled "Safety Requirements for Scaffolding." Section G of this standard deals with two-point suspension scaffolds (swinging scaffolds).

The owner of the Pocket Climber and/or the person responsible for its use or employment must ensure that a copy of this instruction manual is given to the operator of each hoist.

Power Climber reserves the right to make changes or modifications to its hoists. Users of this equipment should request current operating information prior to using this equipment. Call your local Power Climber dealer.

Keep this manual with the hoist at all times.

## Safety Summary

**Every year, workers on swing stages are injured, become disabled, or are killed because of carelessness or because they didn't understand how to properly operate the equipment. Don't become one of them. Know how to use this equipment and prevent accidents.**

**Don't operate equipment that you don't understand. You might cause accidents, resulting in injury or death to occupants or bystanders.**

This instruction manual is not all-inclusive. It is impossible to anticipate every possible way this equipment may be used, and all possible hazardous situations. Therefore, it is very important that anyone using this equipment must determine for themselves whether the equipment is safe. You must be familiar with the operating characteristics of this hoist. You must understand how the hoist will interact with the characteristics of your application. You must be certain not to jeopardize yourself or others, or cause damage to the surroundings or the equipment. Call your local supplier if in doubt.

1. Read and understand this manual **before** using this equipment.
2. Use the troubleshooting guide in this manual to solve problems that may develop with the hoist. Understand the problem before attempting repairs. **Repairs must only be made by people trained and authorized to do so. Never maintain or repair the equipment while the unit is suspended (above ground level).**
3. Be careful when operating the hoist in freezing temperatures, where water or moisture can enter the hoist's overspeed brake or traction assembly. See Cold Weather Operating Instructions in this manual.
4. **Do not remove any parts from the hoist without replacing them. Do not change or substitute any approved hoist parts for parts that are not approved.**
5. Use only approved wire rope, Crosby-type fist grips, thimbles, and other hardware recommended for this equipment.
6. Tighten and re-tighten wire rope fist grips after initial loading and before suspending the live load at the start of each work shift. Manufacturer recommended torque: 30 ft-lbs for 5/16-in. wire rope.
7. Use only solid counterweights designed for the beams being used. **Never** use sandbags, liquid filled containers, or any other free-flowing material as a counterweight.
8. Make sure the roof, parapet, or cornice you plan to use will support the rigging and suspended platform load with a safety factor of at least 4:1 over the rated hoist capacity. Do not attach to a weak or questionable structure. If in doubt, have a qualified engineer certify that the structure is capable of supporting the load.

9. Do not overload the hoist, platforms, or rigging. Do not exceed the rated capacity of any component.
10. Always use the rigging tie backs. Make sure roof rigging tie backs are as strong as the hoisting ropes, are installed without slack at right angles to the face of the building, and are secured to a structural member of the building.
11. **Warning!** Do not use single-point or two-point suspended scaffold unless:
  - You are wearing a properly-attached fall arrest system.
  - You have personally made sure that (1) the roof support system is complete, properly assembled, counterweighted (or otherwise anchored), tied off, and not overloaded; and (2) hoists and platforms are not overloaded.
  - The wire rope is the size and type specified for your hoist.
  - Guards are properly installed.
  - The main suspension wire rope is vertical.
 Setup and use must comply with Power Climber instructions, OSHA, and other applicable codes. Copies are available from Power Climber.
12. Do not reset the overspeed secondary brake if it actuates automatically while the work platform is off the ground. First, thoroughly check to determine the reason for brake operation. The overspeed secondary brake may be the only thing holding you up!
13. All electrical connections must be locked and supported by strain relief devices. The weight of electrical extensions must not be carried by the hoist power inlet plug. If strain relief devices are not included with your supply lines, contact your Dealer to obtain them.
14. There are no adjustable or repairable parts in the brake motor, secondary brakes, and gear box. Only factory authorized personnel are qualified to make repairs to these components.
15. Do not use visibly worn, kinked, bird caged, undersized, or damaged wire rope. Protect wire rope from sharp or abrasive edges of buildings. Do not use wire rope that has been exposed to fire, excessive wear, corrosive atmosphere, chemicals, passage of electric current, or temperatures above 200°F.
16. Inspect the wire rope before rigging. Handle, inspect, and maintain wire rope carefully during and after each job. Lubricate the wire rope according to the manufacturer's recommendations.
17. Provide proper electrical grounding. Avoid arcing when using electrical equipment. When welding, insulate wire rope with a split and taped rubber hose about five feet above and below the hoist. When arc welding, provide a separate grounding wire capable of handling welding current and use an insulated rigging device to ground the wire rope.
18. Always check the soundness of all rigging before using this equipment. Go up and down a few inches several times near the ground to check equipment operation.
19. Never operate an electric hoist in an explosive atmosphere such as a refinery, chemical plant, grain elevator, coal mine or coal handling equipment, or around explosive organic vapors or dust.
20. Work from the deck of the work cage or platform only. Do not stand on stirrups, guardrails, toeboards, or other objects on the platform. Do not use ladders or boxes to get to higher elevations. Do not lean over the hoist or railings. Do not stand outside the hoist at the end of the platform unless end rails are in place.
21. Never operate a work cage or platform without guard rails, mid-rails, and toeboards in place. Use all personal protection equipment.
22. Never use aluminum platforms around caustic materials, acids, or acid fumes. Use approved corrosion-resistant platforms when corrosive materials are present.
23. Maintain clearances and make sure no obstructions interfere with vertical travel.
24. Avoid power lines. Make sure the platform or hand tools cannot swing or be blown within 10 ft. of a power line. Never, under any circumstances, rig a platform above electrical power lines.

25. Make sure the electrical cord is long enough to allow full travel of the suspended equipment. Use electrical cable restraining devices (kellum grips) to protect connections from tension.
26. Only use the operating switch by hand. Do not block or lock the operating switch in a running position.
27. When not in use, store hoist and stage beyond reach. Protect from unauthorized use. Cover the hoist if possible. Always unplug power cord.
28. Do not allow anyone under suspended equipment. If necessary, provide protection below the suspended equipment to prevent injury to people from falling objects. Use lanyards to secure tools and materials from falling on personnel below.
29. Use approved personnel harnesses, lanyards, rope grabs, and independent lifelines at all times. Attach the lifelines to a structural member of the building, never to part of the rigging.
30. Always operate the platform in a level position.
31. Never work alone on a suspended platform.
32. Hard hats must be worn at all times when servicing, erecting, disassembling, or using this equipment.
33. Comply with all local, state and federal safety codes and equipment.
34. Only authorized, properly trained, and physically fit personnel shall operate this hoist. Operator must not be subject to seizures or loss of control, and must not be under the influence of alcohol or drugs.
35. If you hear any strange noises such as "grinding" or if the hoist does not appear to work normally, stop immediately. Do not continue to use the equipment until it is repaired.

#### WARNING

**If the hoist is suspended in the air and the motor runs but the wire rope does not move through the hoist, STOP the hoist immediately! Damaged wire rope may be jammed inside the hoist. Any attempt to move the hoist up or down could damage the equipment or cause injury or death.**

## Hazard Summary

There are many hazards in the workplace, especially when working on a suspended scaffold. The following are common hazards. The list is not intended to be comprehensive; it is provided to increase safety awareness on the job site.

## Mechanical Hazards

- **Crushing** between the roof trolley and the building, or between the platform and the roof rig.
- **Cutting or severing** between moving machine parts.
- **Smashing** the platform against the building face.
- **Loss of rigging stability** because of one or more of the following:
  - Insufficient counterweight, or counterweights not properly fixed.
  - Inadequate mechanical strength.
  - Increase in vertical load on suspension wire because the platform encounters an obstacle, the platform overloads, or the suspension wire rope ruptures.
  - Platform catches on overhang when lowering.
  - Increased horizontal load by a difference in the inter-axle load between the roof rigging and the platform stirrup.
- **Falling** when rigging the roof and hoist wire ropes, from the platform while working, by using a wire rope that is too short, if the platform isn't strong enough for the weight and breaks, or if wire rope or platform interconnections fail.
- **Rigging failure** can cause platform incline, slipping and falling.
- **Slipping** due to loss of traction. Wire rope jam by using incorrect diameter wire rope.

- **Slip, trip and fall hazards.** Pay attention to:
  - decking, sides, guard rails and toe boards on the platform.
  - control of platform level.
  - safe access to the platform.
  - safe access to the wire rope anchorage points.
- **Objects falling from the platform.** Pay attention to:
  - decking and toe board spacing and orientation.
  - special requirements for operating a platform around the general public.

### Electrical Hazards

- Failure of the electrical supply may result in being trapped on the platform.
- Unwanted movement and/or failure of the control system.
- Improper power supply (voltage or frequency) may cause the hoist to operate in a dangerous manner.

### Rigging Essentials

The following is general rigging information only! The rigger must consult the manufacturer's instructions for the specific rigging to be used.

**WARNING**

Rigging is the responsibility of the user. Do not attempt to rig a job unless you know how to do it properly. Contact your Supplier, State Safety Inspector, or a professional rigger for rigging requirements. They will answer any rigging questions you may have.

Use tie backs at all times and be certain that the capacity of the rigging system is at least four times the hoist's rated capacity. Failure to rig properly could result in serious injury or death.

1. Before selecting and installing a rigging system, make sure the cornice, parapet, or roof structure will support the weight of the suspended load and the rigging equipment, with a safety factor of at least 4:1. If in doubt, have a qualified rigging company install the system. Make sure the suspension wire rope remains vertical and that the suspension points are directly above the hoist entry guides or lead-in devices of the hoist at all times.
2. Current U.S. regulations do not require use of a second wire rope except in specific applications. However, for additional hazard reduction, Power Climber has provided an integral auxiliary slack rope brake to be used with a second wire rope.  
We recommend using two wire ropes with each hoist. The second wire rope should be attached to a structural member of the building and protected from sharp edges.  
Always check the rigging before using the equipment. Be sure fist grips are properly tightened. Place a load (equal to the weight of all men and equipment that will be used on the stage) on one end of the platform and run the hoist up and down a few inches near ground level. Move the load to the other end of the stage and repeat the test. Re-tighten all fist grips while the wire ropes are under tension.
3. You must provide a separate lifeline for each person on the platform. The lifeline and tie off point must hold 5,400 lbs. **The tie-off point must be a structural member of the building, not any part of the rigging.** The lifeline must not touch rough or sharp edges.
4. Use only properly engineered parapet clamps and follow the manufacturers' instructions. Never attach to a parapet or similar type structure without a complete inspection and investigation of its structural strength by a qualified professional engineer. Do not attach to a weak or questionable structure. Always tie the parapet clamp back to a structural member of the building.

### Cornice Hooks

These devices are intended to support the wire rope of a suspension scaffold from a building cornice or parapet. Most models have a maximum rated working load of 1,000 lbs, and it is important that the parapet or cornice be capable of sustaining the maximum rated load with a safety factor of at least 4:1. Follow the manufacturer's assembly instructions.

### Outrigger Beam Distance-to-Weight Ratio

1. Measure overhang distance. Unless the rigging is specially designed, the **overhang must not exceed two feet.** Use chart below for correct counterweights.
2. Counterweights must be attached to the outrigger beam. Removal should be prevented by a padlock or similar device.
3. Never use sandbags, liquid-filled drums, or other loose material as counterweights.
4. Measure the length (L) of the beam from the pivot point (outer support) to the center of the counterweights. (See diagram.) For lengths of L between figures on the chart, use the next higher weight.
5. If you are using a specially manufactured outrigger, you must follow the manufacturer's instructions.

The chart below is based on a 1,000 and a 750 pound rated capacity hoist, a 2-ft. overhang, and a 4:1 safety factor. The weights required are for **each beam.**

Length (ft)	Hoist Capacity		Length (ft)	Hoist Capacity	
	1000 lb.	750 lb.		1000 lb.	750 lb.
4	2000	1500	10	800	600
5	1600	1200	11	750	550
6	1350	1000	12	700	500
7	1150	860	13	650	470
8	1000	750	14	600	430
9	900	670			

**Note:** For smaller overhangs (measured in feet), or other capacity hoists, calculate required pounds of counterweight using the following:

$$\text{counterweight} = \frac{4 \times \text{hoist rated capacity} \times \text{overhang}}{L}$$

Use hoist rated capacity in pounds (lb); the overhang and L in feet (ft).

Always check the rigging before using the equipment. Be sure fist grips are properly tightened. Place a load (equal to the weight of all workers and equipment that will be used on the stage) on one end of the platform and run the hoist up and down a few inches near ground level. Move the load to the other end of the stage and repeat the test. Re-tighten all fist grips while the wire ropes are under tension.

### Wire Rope

1. Use only 5/16-in., 8 or 8.4 mm diameter, 6 x 19 or 6 x 31 Seale, right regular lay, improved plow steel, pre-formed wire rope with bright or galvanized finish. Wire rope requires lubrication — under normal conditions, lightly lubricate it with a wire rope lubricant monthly, more often if necessary. Stainless steel wire rope can be used in corrosive environments.
2. If you are using the self-reeving feature of the hoist, you need to prepare the end of the wire rope for insertion. If using IWRC wire rope, cut back the steel center at least 2 in. to allow for independent movement of the core. Braze and rough shape the end of the wire rope to form a smooth, tapered, bullet shape no more than 1/2-in. long.



DO NOT cool the end of the hot wire rope in water or oil. This makes the end brittle and may cause it to break off. Oil the bullet after it cools to prevent rusting.

3. Always uncoil and carefully examine the wire rope before use. Worn, kinked, bird-caged, or damaged wire rope cannot be repaired—it must be replaced.

4. Use only proper diameter Crosby wire rope fist grips. Do not use "U" type wire rope clamps—these crush the wires and damage the rope. Tighten  $\frac{5}{16}$ -in. fist grips to 30 ft-lbs.

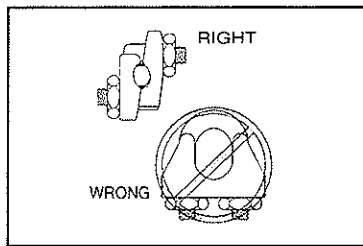

5. Use a heavy-duty thimble and three fist grip wire rope clamps on all attachments, including tiebacks.

- With the wire rope looped around the thimble, attach the first clamp as close as possible. Leave the nuts loose.
- Attach the second clamp approximately 7 in. from the thimble. Tighten moderately.
- Install a third clamp midway between the other two clamps. Slide the first clamp against the thimble and take up the slack in the rope.
- Tighten all nuts evenly to torque value recommended by clamp manufacturer. (See #4 above.)

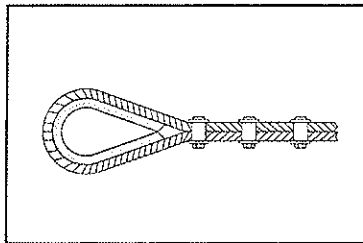

**WARNING**

Because wire rope stretches when loaded, the diameter is reduced and the fist grips may loosen. Therefore, always re-tighten the wire rope clamps once a load has been applied. This is especially important at the start of each work shift.

6. Be sure there is enough wire rope to have three feet extra on the lowest possible point to which the platform can travel.

7. Store extra wire rope on a roof, coiled and tied.

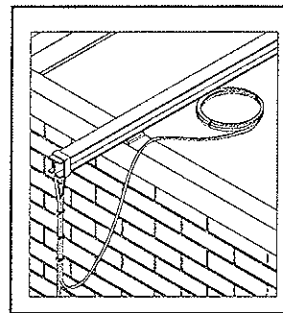
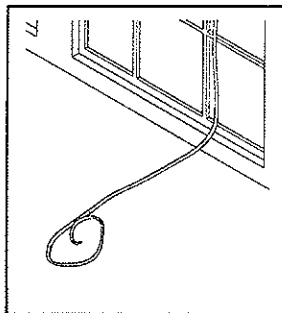

8. If hoist travel is originated from above (near the suspension points such as from a bridge or over a manhole) and it is not possible to lower the platform to the ground, secure the tail line to prevent the platform from running off the suspension ropes. This is done by forming a thimble eye with Crosby clips and securing the tail end to the stirrup.

Before rigging in such an area, consult a safety professional. Additional protection equipment may be required.

9. Wire rope begins to wear the moment it is used. Therefore, it must be regularly inspected to be sure it is in good condition. Wire rope that is used beyond its useful life is dangerous to people and property. Wire rope MUST be taken out of service when ANY of the following conditions occur:

- Four (randomly distributed) broken wires in three lays, or two broken wires in one strand.
- More than one valley break (broken wire). A wire break in valleys between strands indicates an abnormal condition, possibly fatigue. Other broken wires may not be visible.
- Kinked, crushed, bird caged wire rope, or any damage resulting in distortion of the rope structure.
- Evidence of exposure to temperatures above 200° F.
- Rusting, corrosion, or pitting.
- Evidence of core failure (lengthening of a rope lay and a reduction in diameter).
- More than two broken wires in the vicinity of end attachments.
- Reduction of wire rope diameter to 0.290 in. for a  $\frac{5}{16}$ -in. diameter rope. Measure the diameter across the outer limits of the strands, not the valleys, when the rope is under load.

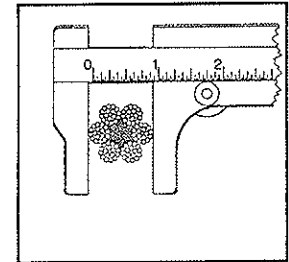

**Note:** Do not expose the wire rope to fire, temperatures above 200° F, passage of electrical current, or corrosive atmospheres and chemicals. This exposure will make the rope unsafe.

Acids will corrode and reduce the strength of both the inner and outer strands. When using corrosive chemicals, use stainless steel wire rope and discard after completing the project, or if any damage is evident. Do not save wire rope that has been in contact with corrosives. When in doubt, replace the wire rope.

**Hoist Description**

The Pocket Climber PC1 is a scaffold hoist with self-reveeing and breech loading capability. It uses a single wrap traction sheave and traction rollers to lift the load. The amount of traction is load dependent—the heavier the load, the more traction you have.

Power is supplied to the traction sheave by an electric induction motor through a double reduction gear drive. In the event of power disruption, controlled descent is provided by manually operating the no-power emergency descent lever.

The hoist comes equipped with several risk reduction features:

- **Emergency Power Cut-off** disconnects the power pack from the supply voltage.
- **Emergency Down Brake** senses the hoist speed as it passes over the main suspension wire rope. The brake operates when hazardous speeds (in excess of about 50 ft/min) are detected. A speed-sensitive governor trigger activates a spring loaded cam. The cam locks the hoist to the rope. This brake can also be manually operated.
- **Auxiliary Slack Rope Brake** locks the hoist to a second wire rope. This brake is activated whenever the main suspension wire rope is slack.

**Note:** Using a second wire rope is optional, unless required by law.

## General Specifications

The hoist comes in the following configurations:

	PC1-1000E	PC1-1000EC	PC1-1000EDV	PC1-1000A	PC1-1000E3	PC1-750EC
Capacity (lbs)	1000	1000	1000	750/1000	1000	750
Speed	35 ft/min	35 ft/min	35 ft/min	up to 35 ft/min	35 ft/min	35 ft/min
Weight (lbs)	102	104	106	88	102	98
Voltage	220 VAC*	110/220 VAC*	110/220 VAC*	90-120 PSI	208/240 VAC*	110/220 VAC*
Current	7 A	7/14 A	7/14 A	40-70 CFM	6 A	5 A
Circuit Breaker	20 A	20/30 A	20/30 A	N/A	20 A	20 A
Dimen. (HxWxD)	20x13x12	21x13.5x13	21x13.5x13	18.5x14x12	20x13x12	20x13.5x13

\* 3-phase + single phase

## Component Parts

The major components of the PC1 Pocket Climber are listed below, and most are identified on the photographs that follow. Refer to these photographs when reading the operating instructions.

1	Main Suspension Wire Rope	14	Electric Supply Plug
2	Second Wire Rope	15	Stirrup Bar
3	Up/Down Controls	16	Access Door with overspeed wheel inspection port
4	Electric Motor with Brake	17	Diverter Cover
5	"No Power" Emergency Descent Lever	18	Tail Line Guide
6	Emergency Power Cut-off Button	19	Tail Line Guide Pin
7	Electric Control Box	20	Slack Rope Lever and Inlet Guide
8	Frame	21	Traction Sheave
9	Traction Roller Assembly	22	Pilot Light
10	Manual Emergency Down Brake Button	23	Overspeed Sensor Wheel
11	Breech Load Traction Roller Hex Shaft	24	Auxiliary Slack Rope Brake & Overspeed Secondary Brake Housing
12	Sheave Guard	25	Reeving Wrench
13	Emergency Down Brake Reset Knob		

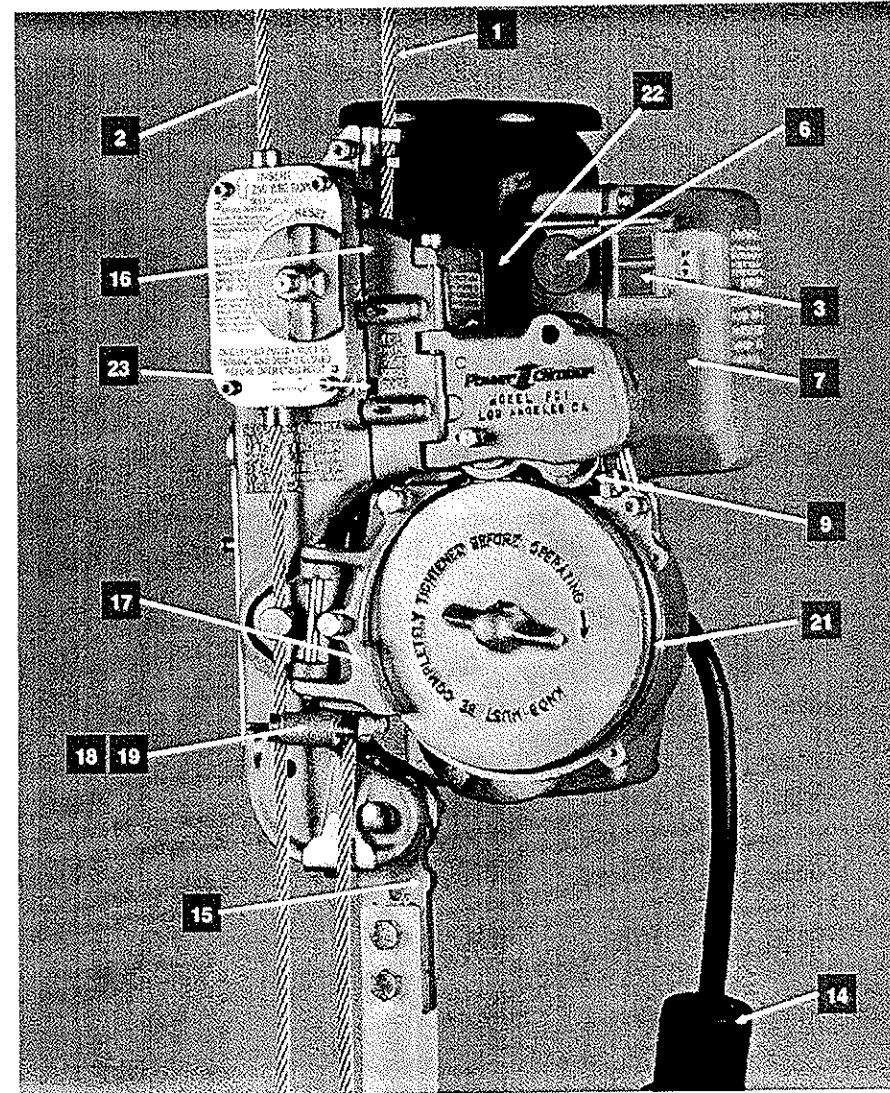

Figure 1. Pocket Climber Front View

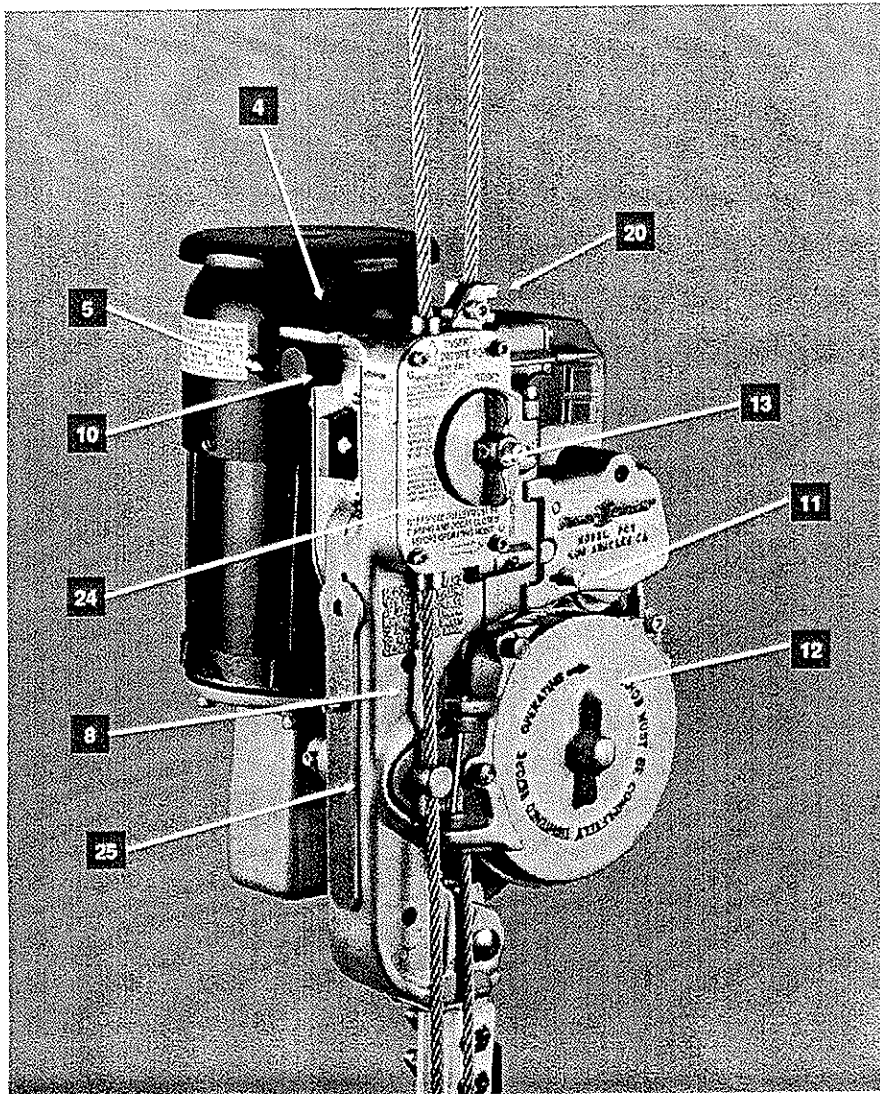

Figure 2. Pocket Climber Left Side View

## Installing to a Platform

The first step is to attach the stirrup and cross beam assembly to the platform. Make sure the jam nuts and cotter pins are properly installed.

**WARNING**  
All bolts and fasteners must be SAE Grade 5 or stronger.

1. Fasten the stirrup A-frame to the stirrup cross beam assembly using Grade 5 bolts. Make sure the castle nuts and cotter pins are properly installed.
2. Attach the traction hoist stirrup bar to the A-frame. The hoist can be lifted by hand (manually) or by reeving the main suspension wire rope and powering the hoist into the stirrup.
3. Connect the hoist to the power supply. All electric hoists have a twist lock plug. The pilot light (22) will illuminate when the hoist is receiving power. The electric supply must have sufficient capacity, and the circuit breakers or fuse must be properly rated.

The minimum circuit breaker ratings and electric motor voltage requirements (at the hoist) are listed in "General Specifications."

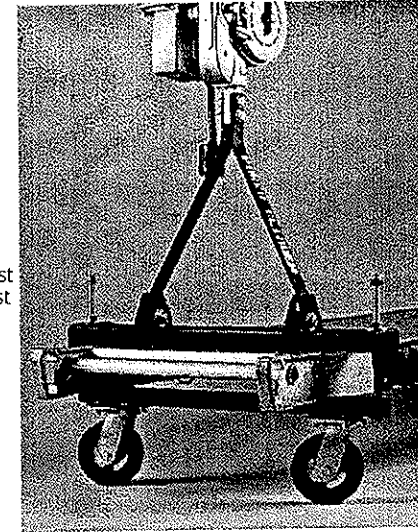

Each 100 feet of 10/3 electrical cable will drop the voltage by approximately 2 volts with one hoist, and 4 volts with two hoists. If start-up is sluggish, determine if the voltage at the motor(s) (when running UP) is 200–230 VAC. You can increase the voltage at the hoist by using larger or separate supply cords, and a booster transformer at the power supply source. When running two motors on one electrical cable, avoid starting both hoists at the same time.

## Reeving the Wire Rope

### Installing the Main Suspension Wire Rope

There are two ways to reeve the main suspension wire rope: self-reeving and breech loading. Choose a method and follow the steps for that method. Do not mix steps from one reeving method to the other.

- Use self-reeving when the end of the wire rope is readily accessible and the hoist will be used within 100 feet of the end of the rope.
- Use breech loading when the hoist is near the top or middle of a long wire rope. This is also the method to use when the end of the rope is damaged or does not have a good bullet, and you want to avoid rope jams.



### Self-Reeving

Make sure the access door (16) and the diverter cover (17), are fully closed and fastened. The traction sheave (21), must be fully in board.

Lift the slack rope lever to a vertical position.

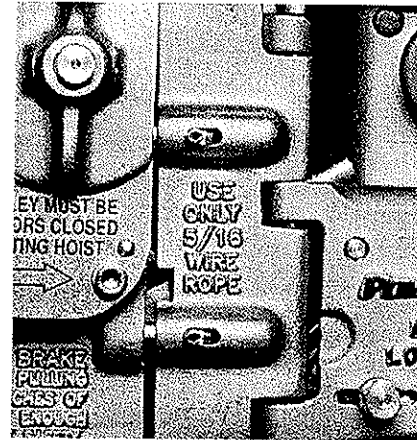

1. Push the main suspension wire rope (1) bullet through the slack rope arm inlet guide (20) approximately 15 in.

Note: Operate the hoist in the UP direction while pushing the rope into the hoist.

2. Make sure the rope runs freely through the tail line guide (18).

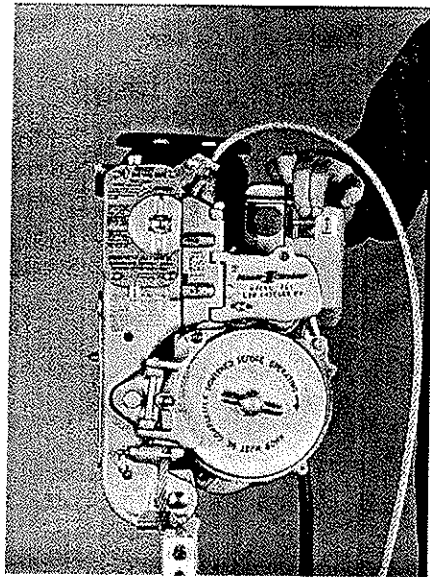
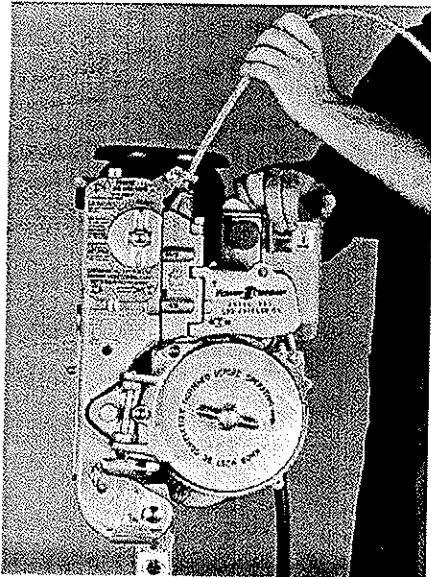

### Breach Loading: Loading the rope from top to bottom

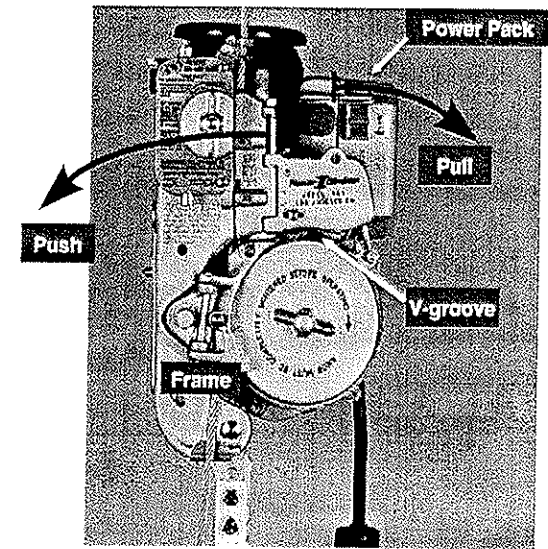

1. Open the access door by sliding the two spring loaded pins from left to right at the same time.
2. Open the diverter cover by loosening the two knurled thumb screws. Swing the cover open.

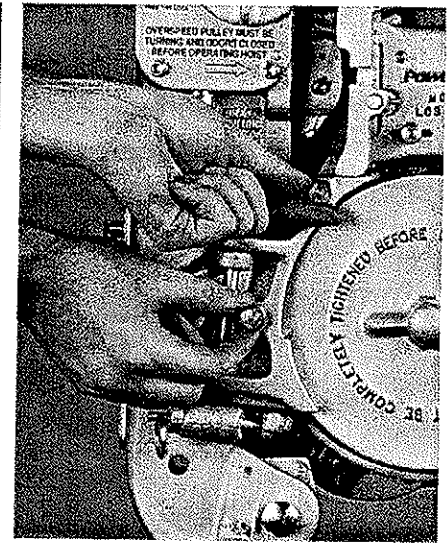
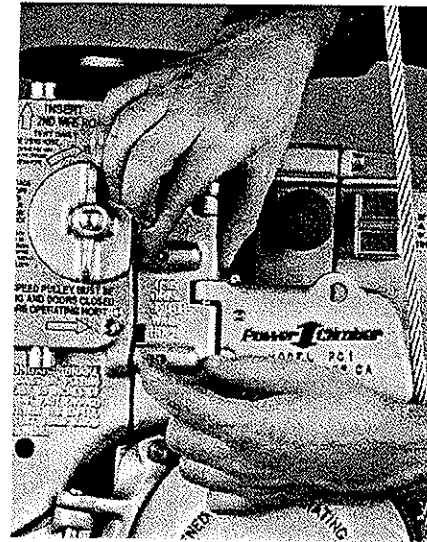

Note: The next two steps require two persons.

3. Push back on the frame, then pull forward on the power pack until the rollers clear the traction sheave v-groove (see illustration at top of page).

4. Turn the sheave guard (12) counterclockwise until the v-groove is exposed.
5. Rotate the main suspension wire rope into the slack rope inlet guide by moving the lever from horizontal to vertical.

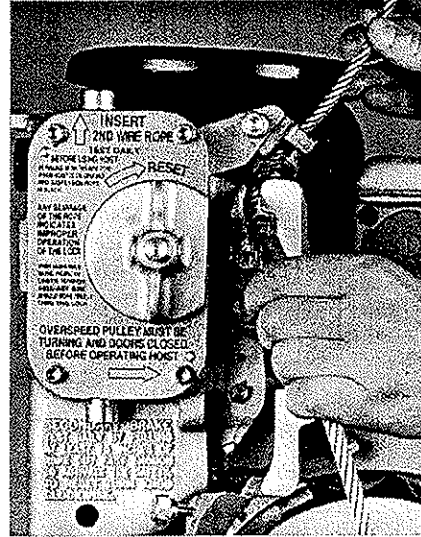
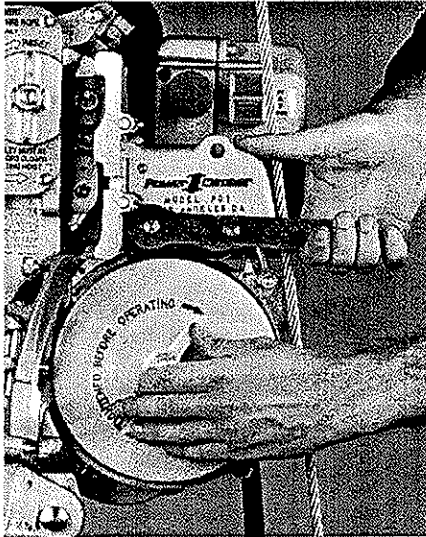

6. Retract the overspeed tension assembly and push the wire rope between the overspeed sensor wheel and the overspeed tension assembly. Reeve the main suspension wire rope under and around the traction sheave, into the v-groove.
7. Insert the main suspension wire rope into the tail line wear plate. Release the pin.

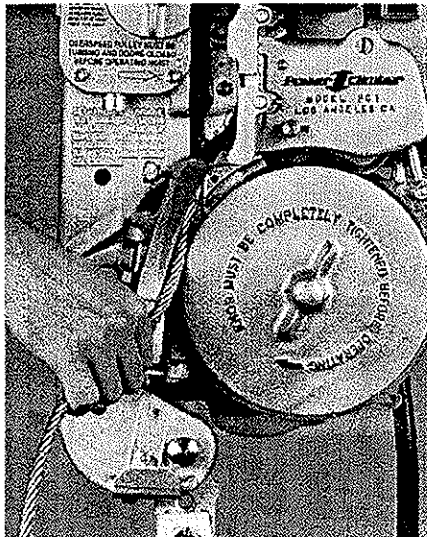

8. Pull on the main suspension wire rope at the bottom of the tail line guide to remove any slack. Make sure the main suspension wire rope is completely seated in the traction sheave v-groove.
9. Turn the sheave guard clockwise until the v-groove and traction roller assembly are aligned. The sheave guard (and sheave) should reach a positive stop when correct alignment is achieved as long as there are no obstructions.

**WARNING**  
Inspect for binding and misalignment of the wire rope, traction sheave and rolling assemblies. Do not proceed until proper running alignment is achieved.

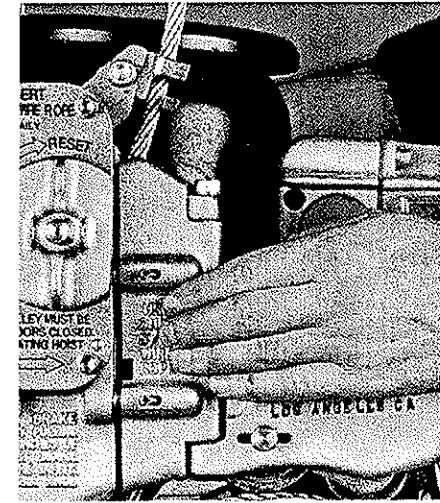
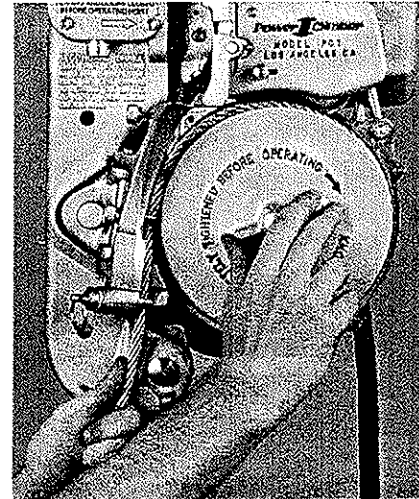

10. Close the access door; slide the spring-loaded pins from left to right at the same time; close and lock the door.
11. Close the diverter cover by swinging the cover closed and tightening the knurled thumb screws. Never operate hoist with the access door or diverter cover open.

**WARNING**  
If either door will not fully close, the hoist is not reeved correctly.

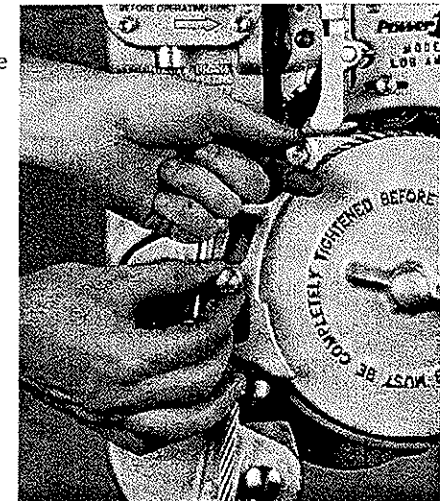

## Installing the Second Wire Rope

1. With a load on the main suspension wire rope (or while manually lifting the slack rope lever) insert the second wire rope into the inlet guide of the *auxiliary slack rope brake* (24).
2. Pull the rope through and hang a 25 lb. weight from the end to keep tension on the rope.

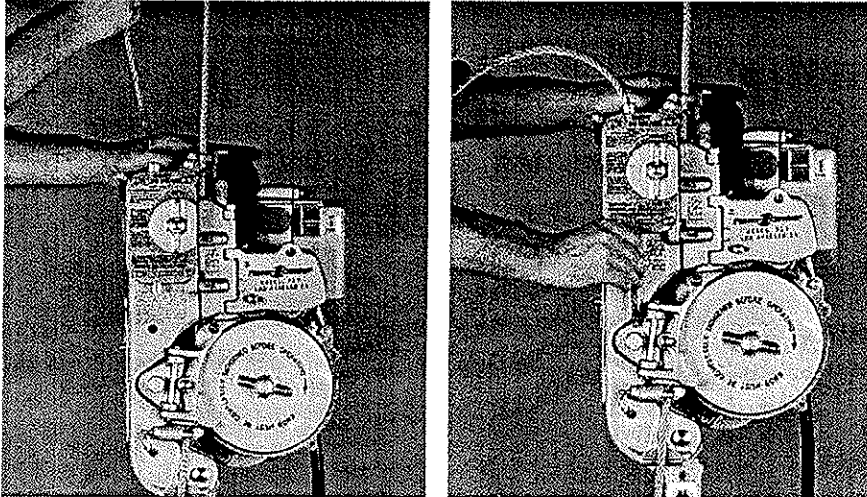

3. Pushing the slack rope lever to the vertical position releases the auxiliary slack rope brake jaws. This allows the second wire rope to pass through the brake housing.

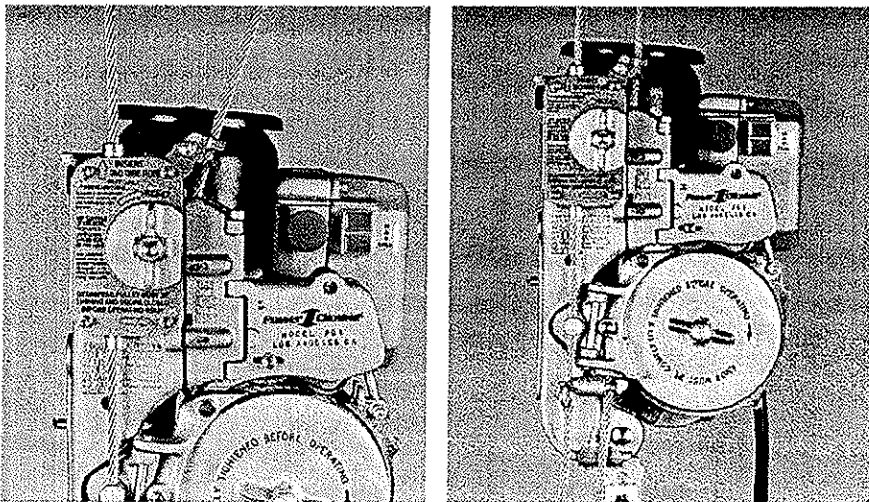

## Daily Test Requirements

The following tests must be performed at the start of each work shift. If the hoist fails any test, **DO NOT** use it until it is repaired. Refer to the photos on pages 11–12 to identify components.

**WARNING**  
Perform all daily tests to ensure correct operation! Do not use the hoist for lifting until you have successfully completed the daily tests.

### Testing the Secondary Overspeed Brake

While powering the hoist up and down approximately 3 ft, look through the notched window in the access door. Make sure the overspeed roller (with the red stripe) is turning with the wire rope.

1. Dereeve the wire rope.
2. Reinsert the rope about 12 in. into the hoist.
3. Holding the wire rope firmly, pull it out quickly. If the brake is working correctly, it will grab and hold the wire rope in less than 4 in.

Repeat this test at least 3 times. If the brake does not work correctly, return the hoist to your Power Climber dealer. **DO NOT USE THE HOIST!**

4. Reset the overspeed brake.

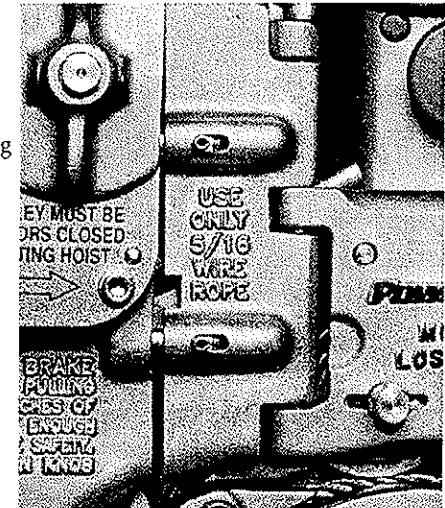

### Testing the Manual Emergency Down Brake

1. Push the UP control button and raise the platform approximately 3 ft.
2. While powering down, push the manual emergency brake button. The hoist should stop quickly.

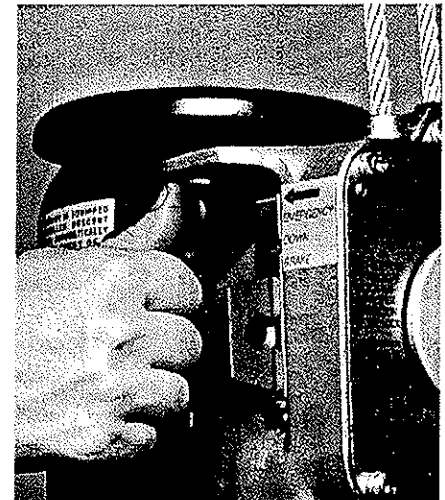

3. Release the *no-power emergency descent lever* (5) to make sure the overspeed secondary brake has locked onto the suspension rope.

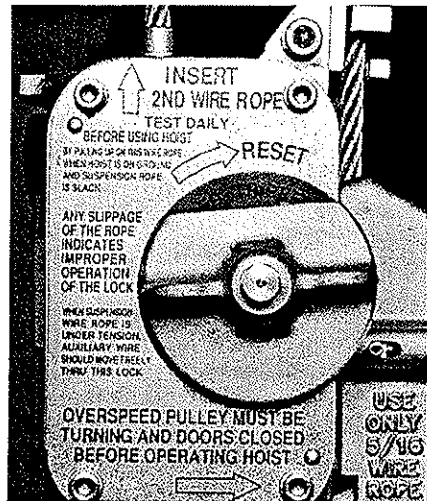

### Resetting the Manual Overspeed Secondary Brake

Power up a few inches, at the same time turning the reset knob clockwise until the reset lever engages. If there is not enough traction to raise the hoist, pull downward on the tail line to increase traction.

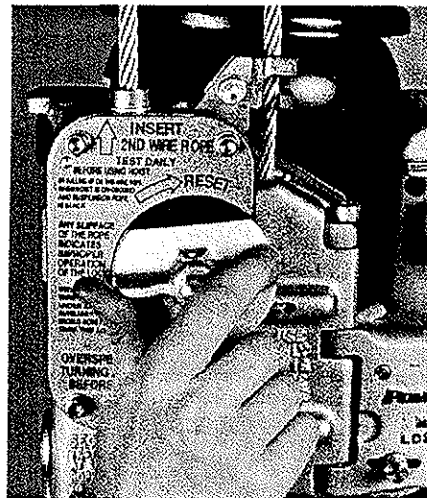

### Testing the Emergency Power Cut-off Button

While running the hoist in either direction, press the red emergency power cut-off button (6). The hoist should not run in either direction. To reset, pull the knob out.

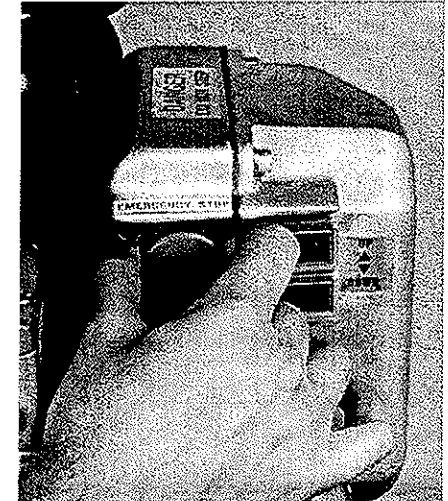
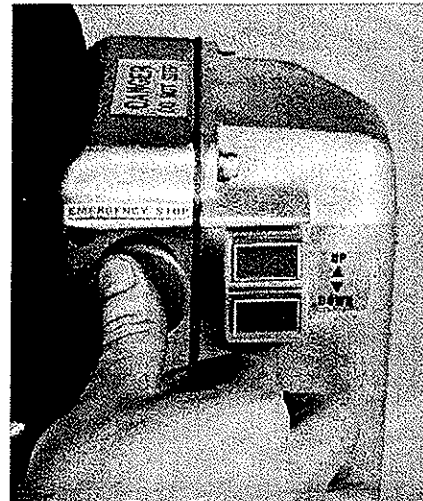

### Testing the Second Wire Rope Brake

Lower the platform to ground level. Slacken the main suspension wire rope. Pull on the second wire rope to ensure that grab jaws are locked onto it. Jaws should release when the main suspension wire rope raises the hoist.

#### CAUTION

Never attempt any maintenance or repair while the scaffold is suspended in the air.

### Testing the No-Power Emergency Descent

1. Raise the hoist approximately 3 feet.
2. Disconnect the power supply. During this test, or when you are actually using the emergency descent, CAREFULLY pull the no-power emergency descent lever, making sure the hoist does not overspeed. The hoist should descend at a slow, controlled speed.

If the hoist travels faster than 35 ft/min, the emergency descent system is not working properly and should not be used.

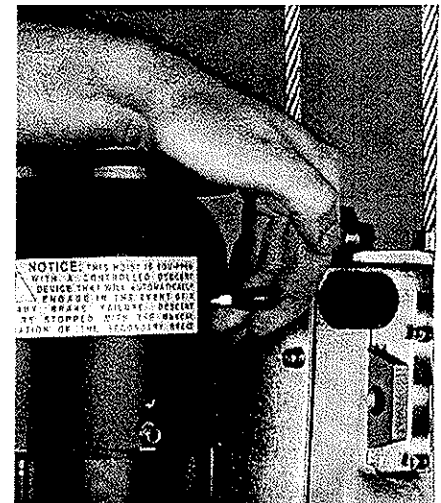



## Daily Inspection

Inspect the wire rope, power supply, rigging, platform, and hoist to make sure they are in proper working order and are not damaged. Bolts, nuts, and clamps must be tight and well secured.

Make sure the stirrup frame is secured with SAE Grade 5 hardware and all nuts and cotter pins are properly installed.

**Note:** When using the hoist in a dirty environment that contains epoxy, paint, cement, sand blast residue, or corrosive materials, inspect the secondary overspeed brake several times a day. Protective covers are recommended for use in such environments. Contact your local supplier.

## Operating the Hoist

### WARNING

**BEFORE operating this hoist you must understand and follow the instructions in this manual. You must be properly trained, physically fit, and authorized to operate the hoist. Failure to comply with these instructions could result in serious injury or death.**

### Safety Notes

- DO NOT operate hoist if you hear any unusual noises.
- DO NOT operate hoist if adjustments or repairs seem necessary.
- DO NOT operate hoist if any warning, operating, or capacity instructions are unclear or damaged. Report any problems to your supervisor and also notify the next operator when changing shifts.
- NEVER operate an electric hoist or any electrical equipment in an explosive atmosphere. Explosive atmospheres exist around refineries, chemical plants, grain elevators, coal mines or coal handling equipment. This is not a comprehensive list. Consult an expert if you are in doubt about the safety of your immediate surroundings.

## Normal Operation

For routine up or down movement of the electric powered hoist, push the up or down control button. The buttons are spring loaded and should return to the off position and apply the brake when released. If the hoist does not stop right away, press the *emergency power cut-off button* (6) and the *manual emergency brake button* (10), and unplug the power.

### Emergency No-Power Descent

Carefully release the primary brake by pulling the *no-power emergency descent lever* (5) slowly toward the top end of the motor. The hoist should descend at a controlled speed.

To stop the hoist, release the no-power emergency descent lever. Using the emergency descent for long drops causes wear on the brake.

USE ONLY IN CASE OF EMERGENCY.

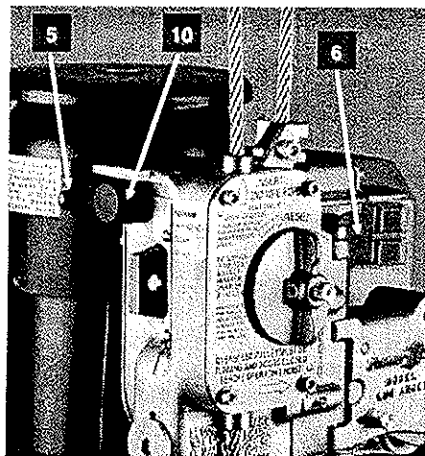

### WARNING

Always allow the hoist to come to a complete stop before changing direction. Failure to come to a complete stop may prevent the hoist from traveling in the opposite direction and could result in serious injury or death.

## Cold Weather Operation

When operating in cold weather, test the secondary brake frequently to make sure it is not frozen. If the brake does not stop the unit, DO NOT USE the unit until the brake has been thawed, dried, and is in proper working condition. Thaw out the brake by blowing ducted dry heat (200° F max) on the brake area or by pouring alcohol on the brake mechanism. Do not use open flame on the unit. If the unit will not operate properly after thawing, DO NOT USE. Return the hoist to your Power Climber dealer.

### WARNING

Be extremely careful when using the hoist in freezing temperatures where water or moisture can enter the overspeed brake or traction assemblies. The emergency overspeed brake must be checked frequently when operating in these conditions.

## Dereeving

### Removing the Second Wire Rope

To remove the second wire rope, the auxiliary slack rope brake jaws must be held open. Remove the 25-lb. weight from the end of the rope. Pull the rope up through the auxiliary slack rope brake housing. It is easiest to remove the second wire rope while the hoist is suspended just above the ground (before dereeving the main suspension wire rope). The jaws can also be held open by manually pushing the slack rope lever to the upright position.

### Removing the Main Suspension Wire Rope

There are two ways to dereeve the hoist — self dereeving and breech unloading. Make sure the stage is properly supported on a stable surface before slacking the main suspension wire rope — the stage and hoist can tip over and cause injury.

#### Self Dereeving

The main suspension wire rope will normally wind out of the hoist when the machine is run in the down direction, as long as the slack rope lever is held in the up-right position. You need to help remove the last 15 in. of rope. Grab the wire above the slack rope inlet guide, hold the overspeed secondary brake reset knob in the reset position, and slowly pull the main suspension wire rope out of the hoist. If the hoist does not reeve or dereeve, push the motor upright to increase traction.

#### Breech Unloading

Follow the breech loading instructions in reverse order. See page 15.



## Periodic Maintenance

The hoist should be returned to a factory authorized service center for periodic maintenance at least once a year from date of purchase. More frequent service may be required if the hoist is subjected to extreme or poor environmental conditions.

Troubleshooting at the Job Site		
Problem	Likely Cause & Solution	
<b>1</b> No power to the platform (hoist power indicator light is not on)	1. Power at the junction box is off.	
	2. Circuit breakers in the building have tripped or fuses blown.	
	3. Plug and receptacle connectors not intact (check hoist, yoke, or extension cord).	
	4. Damaged electrical cord.	
	5. Loose or damaged overspeed control cable connector.	
	6. Power indicator light bulb burned out.	
<b>2</b> Hoist does not run (hoist power indicator light is on)	If electric motor is hot, the thermal overload switch may have tripped. This can be caused by too low or too high voltage. It can also be caused by long, continuous running periods with frequent stops/starts, high outside temperature, or if the primary brake is dragging.	The electric motor must be allowed to cool down before the thermal overload device will automatically reset. This can take thirty minutes or more.
	Increase hand pressure, or lift the motor, while pushing the UP button.	
<b>3</b> Wire rope will not reeve through machine	Take the wire rope out, turn it, and put it back in while pushing the UP button.	
	Poor bullet on end of wire rope.	Prepare a new end.
	End of wire rope is bent or kinked.	Straighten or replace.
	Dirt or other material is in the hoist.	Clean drive mechanism by blowing out with air or flushing with water.
<b>4</b> Hoist motor runs freely but hoist will not lift	Make sure the tail line is free to move out of the hoist.	
	Check the wire rope for damage or wear.	Replace if necessary.
	Wire rope may be jammed in the drive mechanism. This can be caused by kinked or damaged wire rope.	If a rope jam has occurred, <b>do not operate hoist</b> . Call Service Department for assistance. Do not open diverter cover or access door if hoist is suspended above the ground.
	Transmission assembly movement may be blocked.	Check for blockage; correct.

Problem	Likely Cause & Solution	
<b>5</b> Hoist hums, starts slowly, or is sluggish	Check for proper voltage at hoist when running. If voltage is too low, do one of the following:	
	1. Run separate electrical cords to each hoist. 2. Use a shorter electrical power cord if possible. 3. Use an electrical cable with larger conductors. 4. Add a booster transformer at the building electrical plug to increase supply voltage.	
<b>6</b> Overspeed flywheel is not turning	If the hoist is suspended:	Push the manual emergency down brake button and the emergency power cut off button. <b>Wait to be rescued.</b> Do not use hoist until situation is corrected.
	If hoist is on the ground, one of the following may have occurred:	Obstruction such as dirt or other material is in the overspeed secondary brake. If possible, first disconnect electric power, then remove cover plate and clean assemblies. Main suspension wire rope may be worn smooth. Replace wire rope. Hoist parts may be worn. Contact the Service Department.
<b>7</b> Can't reset overspeed secondary brake knob	If the wire rope is reeved through the hoist, you must first move the hoist upward (taking the load off the cam/grab block). Then reset by turning the reset knob clockwise.	
<b>8</b> Auxiliary slack rope brake is not operating properly (on second wire)	1. Clean and lubricate mechanism by removing cover plate. 2. Check inlet guide for freedom of movement. 3. Test the brake.	
<b>9</b> Hoist does not stop immediately when DOWN button is released	Brakes need repair. If the hoist is suspended in the air, travel downward to a safe level and have the brake repaired by the Service Department.	
<b>10</b> You hear a grinding noise	If the hoist is suspended:	Push the manual emergency down brake button and the emergency power cut off button. <b>Wait to be rescued!</b>
	WARNING – You may have a rope jam. Any attempt to operate the hoist could cut the rope and kill you!	
	If the hoist is on the ground:	1. Check for damaged wire rope inside the hoist. Replace the wire rope. 2. Check for dirt on the wire rope; clean and lubricate the rope. 3. Check the motor fan for cracks or broken blades. 4. The gear box or traction sheave internal gear may need lubrication. Call the Service Department.